

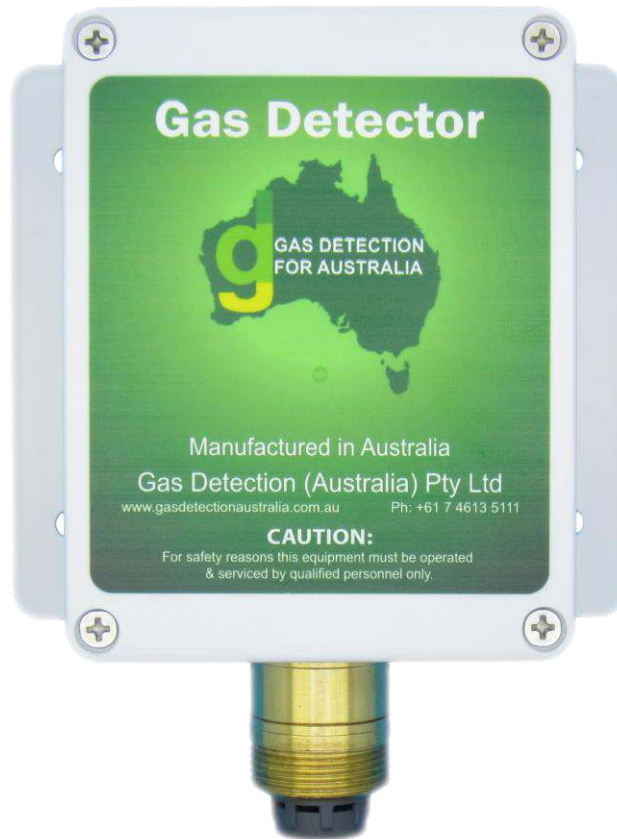

Gas Detection (Australia) Pty. Ltd.

GDA 2500 Series Loop Powered Sensor Operating Manual

Manual Revision: 2.1
Hardware Version: 2.6



Thank you for purchasing this product from Gas Detection (Australia) Pty. Ltd.

This manual contains information about the method of installation and operation of the GDA 2500 series of gas sensors. Please read it carefully and keep it nearby for further reference.

If you have any further question about the product, please contact us.

Location: Unit K1, USQ, Baker Street Toowoomba, QLD 4350

Address: PO BOX 597, Darling Heights, QLD 4350

Phone: +61 7 4613 5111

Web: www.gasdetectionaustralia.com.au

Email: sales@gasdetect.com.au

Note:

The calibration period for a sensor will depend on a number of factors such as the environment in which it is used, operating temperature, humidity, atmospheric pressure and environmental pollutants.

In all cases we recommend sensors are calibrated in line with target market legislation.

In order for these sensors to maintain operational efficiency and performance it is recommended that the sensors are checked for calibration on a periodic cycle. An appropriate bump test gas used according to the period stated in Table 2. Calibration should be carried out according to the periods stated in Table 2 with the appropriate Calibration gas.

The calibration should be carried out by fully trained and authorised and approved technicians approved by GDA.

It is a further manufacturer's recommendation that sensor head assembly be replaced every 2-3 years or earlier if the calibration or periodic test fails.



WARNINGS

The GDA 2500 Series Sensors are only to be used in areas classified as SAFE AREAs. The sensor is not designed for use in classified HAZARDOUS AREAs.

If GDA 2500 Series Sensors are used for safety critical applications the Calibration/Bump test period should be evaluated according to risk management procedure associated the area the sensor is installed.

The GDA 2500 Series Sensors use an electrochemical sensor, the chemical is used up when the target gas is present. Therefore the chemical in the sensor will be used up at a faster rate, shorting its life. From the time of calibration at the GDA factory the sensors output accuracy will have degraded and may require re-calibration if some time has elapsed.

The sensor element contains substances that can be harmful to health. In the unlikely event of a sensor element leaking, the sensor contents should not be touched. If the sensor contents come in contact with eyes or skin, please seek immediate medical attention.

The sensor is designed to work only with the GDA transmitter. Connection to any other transmitter will damage the sensor.

It is important not to exceed the specified DC voltage as indicated in this manual.

PROPRIETARY RIGHTS

No part of the hardware or documentation may be reproduced, transmitted, transcribed, stored in a retrieval system, or translated into any language or computer language, in any form or by any means, without prior written permission of GDA.

While great efforts have been made to ensure the accuracy and clarity of this document, GDA assumes no liability resulting from any omissions in this document, or from misuse of the information contained herein. The information in this document has been carefully checked and is believed to be entirely reliable with all of the necessary information included. GDA reserves the right to make changes to any products described herein to improve reliability, function, or design, and reserves the right to revise this document and make changes from time to time in content hereof with no obligation to notify any persons of revisions or changes. GDA does not assume any liability arising out of the application or any use of any product or circuit described herein; neither does it convey license under its patent rights or the rights of others.



Table of Contents

1. Overview:	5
1.1. Introduction.....	5
1.2. Specifications:	6
1.3. Sensor Specifications:.....	7
2. Sensor Placement:	8
3. Wiring Instructions:	9
4. Operation:	10
5. Calibration and Functional Test:	11
5.1. Zero point Calibration	12
5.2. Span point Calibration.....	13
5.3. Test mA Output	14
6. Sensor Head Replacement (25xx-002):	15
7. Revision History	16



1. Overview:

1.1. Introduction

The GDA 2500 Series gas sensors have a loop powered 4-20 mA transmitter with an electrochemical gas sensor module.

The gas sensor transmitter is a current loop powered device which provides a 4-20 mA current value corresponding to the target gas concentration present. It accepts a range of electrochemical sensor modules see Table 2 for gas types and ranges. The electrochemical sensor cell is enclosed in a Brass or PTFE sensor module which is replaceable.

The transmitter is housed in an IP56 PVC plastic enclosure with the sensor module protruding from the enclosure base with an IP53 (PTFE IP22).

The electronics of the transmitter are calibrated to the target gas and will not require alteration when received from the GDA factory.

The sensor element will expire after approximately 24 months in Standard Ambient Temperature and Pressure (SATP 25°C @ 101.325 kPa) conditions and is easily replaced by disconnecting the plug on the transmitter and unscrewing the sensor module.

The sensor should be connected as per the wiring diagram in Figure 4 on page 9.

It is important when wiring the sensor that the cables screen/shield is connected to the sensor transmitter connector labelled Earth and is only earthed to the system earth at the controller end of the sensor cable.

Label interpretation:

- | | |
|-------------------------|---|
| 1. Product: | Model, Name of detectable gas and its chemical formula |
| 2. Part Number: | Product part number of detector, sensor head, controller... |
| 3. Serial Number: | Serial number of detector, sensor head, controller... |
| 4. Sensor Serial No.: | Serial Number of the Sensor module (May not appear on same label) |
| 5. Range: | Range of sensor and units (ppm, %vol., %LEL) |
| 6. Date of Manufacture: | Date of Manufacture/ Date of Calibration |

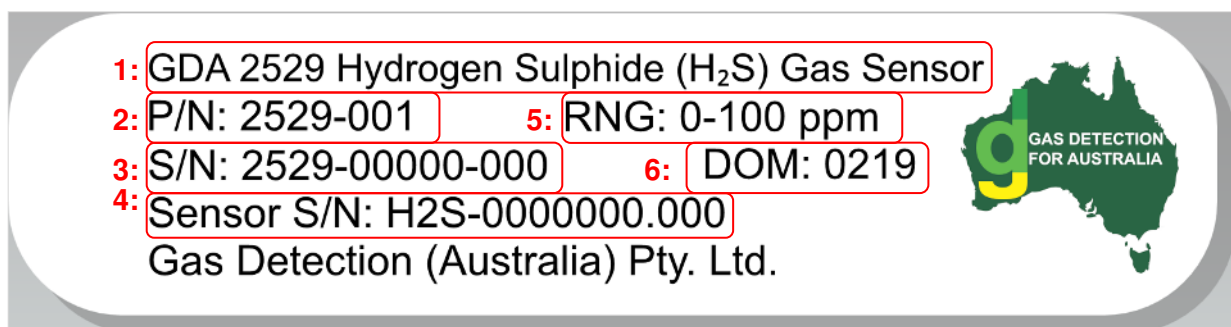

Figure 1: Label interpretation



1.2. Specifications:

Series	GDA 2500
Operating Voltage	+24 V _{DC} from a regulated power supply
Output Type	4-20 mA Loop Powered
Power Consumption	<25 mA @ 24 V _{DC}
Connection	3 pin plug connector; 24 V _{DC} , mA O/P & Earth
Wiring	2 core 18 AWG with overall screen
Output Specifications	Max loop impedance 680 Ω @ 24 V _{DC}
Detection Type	Diffusion
Sensor Technology	Electrochemical Cell
Cable Entry	2 x M20 top entry
Enclosure Material	PVC plastic & Brass C385 / PTFE
Dimensions	155/145 x 130 x 70 mm (H, W, D)
IP Rating of Enclosure	IP56 with sensor module IP53, PTFE IP22
Weight	320g, PTFE 260g

Table 1: Specifications

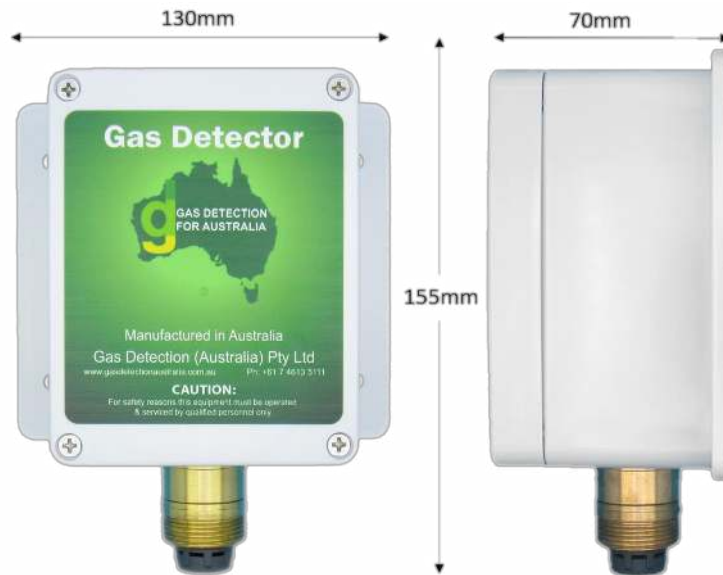

Figure 2: Sensor dimensions

1.3. Sensor Specifications:

Table 2: Gas Sensor specifications

Model	2525	2526	2527	2528	2529	2530
Detection Gases	Carbon Monoxide	Ammonia	Nitrogen Dioxide	Oxygen	Hydrogen sulphide	Sulphur Dioxide
Chem. Formula	CO	NH ₃	NO ₂	O ₂	H ₂ S	SO ₂
Ranges	0-100 0-150 0-200	0-100 0-300 0-1000	0-30	0-25	0-100	0-10
Units	ppm	ppm	ppm	% vol.	ppm	ppm
Maximum Gas concentration Overload	5000	200 500 1500	200	30	500	150
Accuracy of calibration ¹	< 0.5% F/S	< 0.5% F/S	< 0.5% F/S	< 0.5% F/S	< 0.5% F/S	< 0.5% F/S
Response Time T90 at SATP	<30 sec	<60 sec	~30 sec	<10 sec	~30 sec	<30 sec
Linearity	Linear	Linear	Linear	Linear	Linear	Linear up to 20 ppm and within ±5%
Repeatability	<±2% CO	±10%	<±2% NO ₂	-	< ±2% H ₂ S	< ±2% SO ₂
Warm Up Time	~ 30 seconds	~ 30 seconds	~ 30 seconds	~ 30 seconds	~ 30 seconds	~ 30 seconds
Output Drift per annum at SATP in Fresh Air	< 5%	< 20%	< 20%	< 5%	< 15%	< 15%
Recommended time between Calibration operated at SATP in Fresh Air	Annually @ ~ 5% allowed drift ²	6 months @ ~ 10% allowed drift ²	6 months @ ~ 10% allowed drift ²	Annually @ ~ 5% allowed drift ²	6 months @ ~ 10% allowed drift ²	6 months @ ~ 10% allowed drift ²
Recommended time between Bump Test operated at SATP in Fresh Air	6 months @ ~ 3% allowed drift ²	3 months @ ~ 5% allowed drift ²	3 months @ ~ 5% allowed drift ²	6 months @ ~ 3% allowed drift ²	3 months @ ~ 5% allowed drift ²	3 months @ ~ 5% allowed drift ²
Filter Capacity	-	-	-	-	-	1000 ppm hours @ 25 ppm H ₂ S
Operating Temperature	-30°C to 50°C	-40°C to 50°C	-30°C to 50°C	-30°C to 50°C	-30°C to 50°C	-30°C to 50°C
Operating Humidity, peak non condensing	15% to 90% RH	15% to 90% RH	15% to 90% RH	5% to 95% RH	15% to 90% RH	15% to 90% RH
Operating Pressure	800 to 1200 mbar	800 to 1200 mbar	800 to 1200 mbar	800 to 1200 mbar	800 to 1200 mbar	800 to 1200 mbar
Gas density compared to Air (1.205 kg/m ³) @ NTP	Approx. 1.165	Lighter 0.717	Heavier -	Approx. 1.331	Heavier 1.434	Heavier 2.279

¹ Accuracy of Calibration does not include calibration bottle accuracy.

² To remain within an allowed drift of #% of Full Scale output. If target gas is expected to be present during normal operation the calibration period of the sensing element will be reduced.



2. Sensor Placement:

The recommended sensor instillation height is determined from:

- The properties of the target gas (Table 2).
- Properties of other gases present.
- The temperature of the gasses present.
- Air flow in the detection space.
- If the space is occupied or unoccupied.

For heavier gas the sensor should never be mounted with the sensor head pointing upwards, as gas can pool in the sensor and cause constant high or false readings. Take into account drafts and air movements when mounting the sensor.

The three recommended instillation heights depending on the target gas and the environment are;

- Lighter gases rise, install within 300 mm of the ceiling
- Gases similar to air are to be installed in the Breathing Zone 1.0m to 1.8m from the ground.
- Heavier gases fall, install 300 mm from ground

Below shows allowable mounting orientations for the GDA 2500 depending on the target gas.



Figure 3: Sensor mounting orientation.

Note the IP rating is only maintained in the **normal orientation**.



3. Wiring Instructions:

The sensor is a two-wire loop-powered 4-20 mA device. The sensor is designed to work with 24 V_{DC} from a regulated power supply. The sensor transmitter is wired to the GDA range of control units with a 2 core cable with an overall screen/shield or a 3 core 18 AWG cable. The screen or third wire should be connected to the Earth connection of the sensor.

- The +24 V_{DC} is wired to **+VDC** (indicated on the PCB).
- The 4-20mA output of the sensor which connects to the controller is wired to **O/P**.
- The screen of the 2 core cable is wired to **Earth** of the three way connector.

Brass sensor modules provided with an earth wire must be wired to **Earth** of the three way connector as shown below.

It is important that the Screen/Shield of the sensor cable is connected to the power supply earth at the control unit.

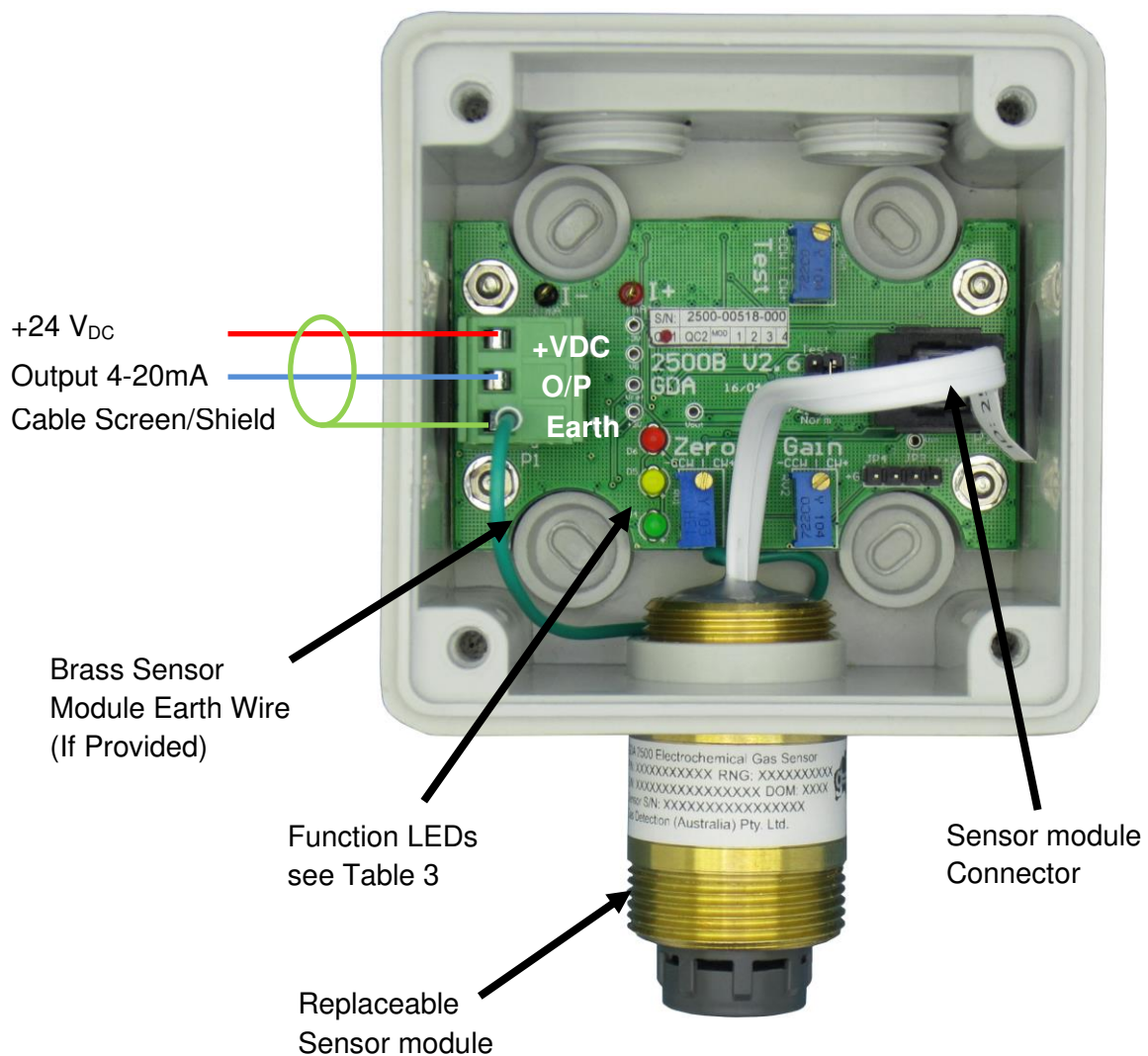

Figure 4: Sensor Wiring

4. Operation:

The sensor has three LEDs which indicate the status of the sensor. After an initial warm up period.









LED	Sensor output	Function
  	>12.00mA to 20.00mA	The red and amber LEDs indicate that the sensor has detected the target gas at half scale or above.
  	<12.00 mA to 4.00mA	The amber LED indicates that the sensor has detected the target gas at below half scale and zero units of the target gas.
  	<4.00 mA	The green LED indicates that the sensor detects zero units of the target gas.

Table 3: LED Status

The GDA 2500 transmitter gas type selection jumper is factory set for the required target gas.

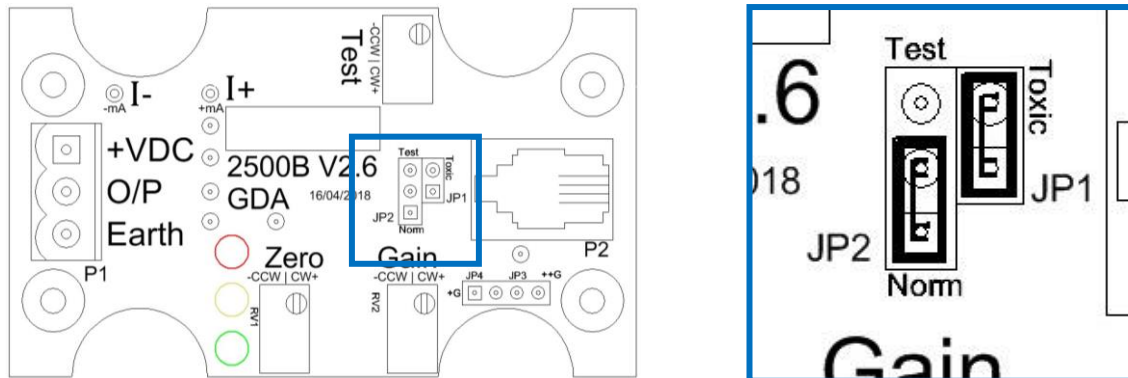

Toxic Gases; O₂, CO,
NH₃, H₂S, SO₂ & Cl₂

Figure 5: JP1 gas type selection jumper

5. Calibration and Functional Test:

Sensors are issued tested & pre-calibrated under controlled lab conditions. Changes to humidity, temperature, and other environmental factors affect the sensor accuracy and may need an adjustment of the Zero point when introduced to new environments.

THE SENSOR MUST BE FULLY POWERED FOR A MINIMUM OF ONE (1) HOUR BEFORE CALIBRATION IS CARRIED OUT.

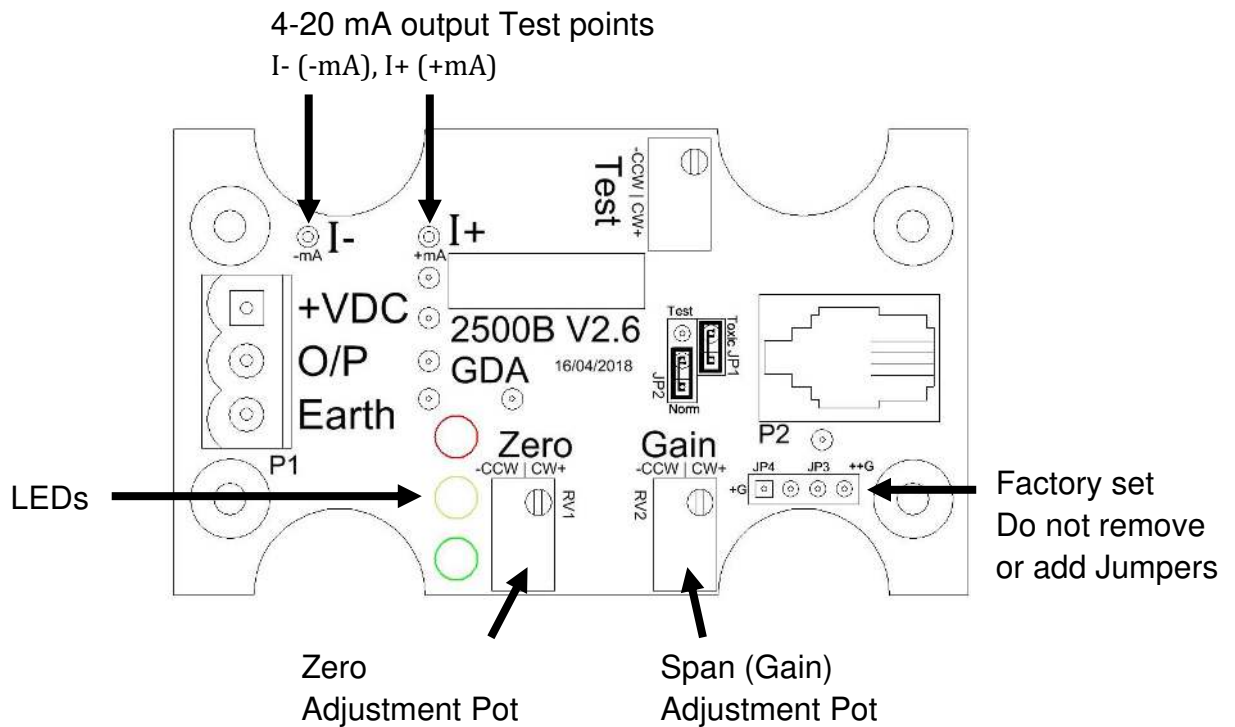

Figure 6: Calibration adjustment pots and rang selection

5.1. Zero point Calibration

The Zero point is when there is none of the target gas present (e.g. 0 ppm CO, 0% vol. O₂).

A Zero point calibration adjusts the 4.0 mA point of the transmitter to correspond to a zero target gas concentration.

Calibrate using the 4-20 mA test points and a multimeter see Figure 6 for mA output test points and adjustment pots.

The 4-20 mA current output of the sensor can be monitored with a current meter set to the 30 mA range.

1. Use the GDA 2500 gassing cap and introduce 100% vol. nitrogen at a rate of approximately 0.5 L/min or in Fresh Air which contains none of the target gas.
2. Apply the multimeter to the sensors 4-20 mA current test points see Figure 6 (observing the polarity).
 - a. To adjust the sensors zero point turn the ZERO pot until the current meter value is 4.00 mA note the value may vary ± 0.05 mA.
 - b. Observe the multimeter value, if the value is above 4.00 mA turn the ZERO POT SLOWLY in the anti-clockwise direction till the value is below 4.00 mA.
 - c. The recommended Zero point current should be equal to or below 4.00 mA and above 3.90 mA.
 - d. The Zero point is now set, the Green LED should be illuminated;
3. Turn off nitrogen gas.



5.2. Span point Calibration

The Span point is set when the sensor is exposed to a known concentration of the target gas. This is normal at half or full scale of the sensor (e.g. 100 ppm CO, 18% vol. O₂).

Calibration using the 4-20 mA test points and a multimeter see Figure 6 for mA output test points and adjustment pots.

The 4-20 mA current output of the sensor can be monitored with a current meter set to the 30 mA range.

1. Use the GDA 2500 gassing cap and introduce the calibration gas (e.g. 100ppm CO) at a rate of 0.5 L/min for approximately 120 seconds (Sensor dependent). With the multimeter on the mA test points.
 - a. When the current meter value stabilises (the value may flicker ± 0.05 mA) adjust the SPAN (Gain see Figure 6) pot until the required mA value is displayed on the current meter. See Table 4 below calculations to determine the correct mA value for the calibration gas.
 - b. The Red and Orange LEDs should be illuminated when the mA value is above 12.0 mA
 - c. The SPAN is now set,
2. turn off the gas and replace sensor cover

Gas concentration calculations:

Example calculation for a 0-200 ppm sensor using calibration gas of 100 ppm, the transmitter board output will be 12.00mA.

1. $16mA \div Range = mA \text{ per ppm}$
 $16mA \div 200ppm = 0.08 \text{ mA/ppm}$
2. $(mA \text{ per ppm} \times Cal \text{ Gas Concentration}) + 4mA = mA @ Concentration$
 $(0.08mA/ppm \times 100ppm) + 4mA = 12.00mA @ Concentration$

Table 4: Calibration mA example calculations

Chem. Formula		CO	NH ₃	NO ₂	O ₂	H ₂ S	SO ₂	Cl ₂
Sensor Range		0-200 ppm	0-100 ppm	0-30 ppm	0-25% vol.	0-100 ppm	0-10 ppm	0-10 ppm
Calibration gas	value	100 ppm	50 ppm	10 ppm	18% vol.	25 ppm	5 ppm	2 ppm
	mA	12.0 mA	12.0 mA	9.3 mA	15.5 mA	8.0 mA	12.0 mA	7.2 mA
Full Range Calibration gas	value	200 ppm	100 ppm	30 ppm	20.9% vol. (Fresh Air)	-	10 ppm	-
	mA	20.0 mA	20.0 mA	20.0 mA	17.4 mA	-	20.0 mA	-
TWA		25 ppm	25 ppm	3 ppm	-	10 ppm	2 ppm	1 ppm peak
STEL		-	35 ppm	5 ppm	-	15 ppm	5 ppm	-



5.3. Test mA Output

The sensor transmitter board has a current output test function. This is used to simulate the current output signal of the transmitter board for functional testing of the system.

The simulated mA current has an adjustable range from 4 to 20 mA. To use the test current function, set jumper JP2 to the Test position see Figure 7 below. The Test current pot adjustment screw can be rotated with a small flat screw driver to increase or decrease the mA output.

Ensure that the JP2 jumper is repositioned to its Normal operating position after functional testing to ensure sensing operation (Figure 8).

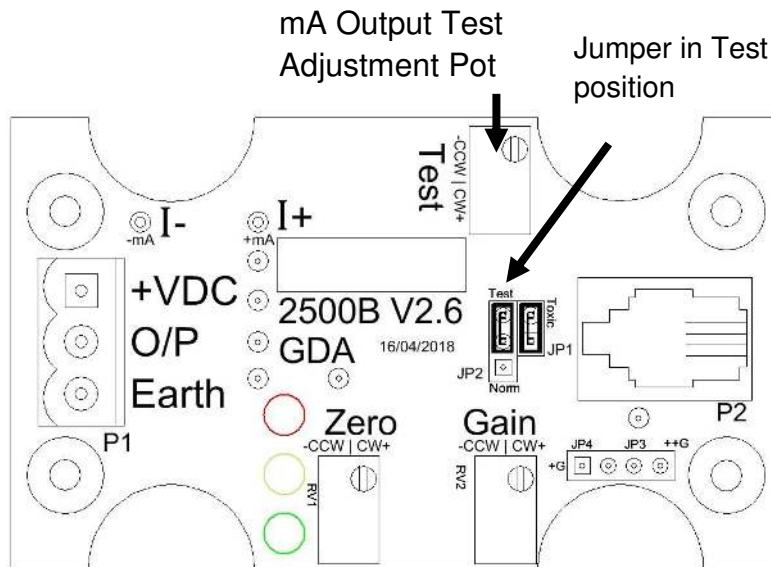

Figure 7: JP2 Jumper in Test position

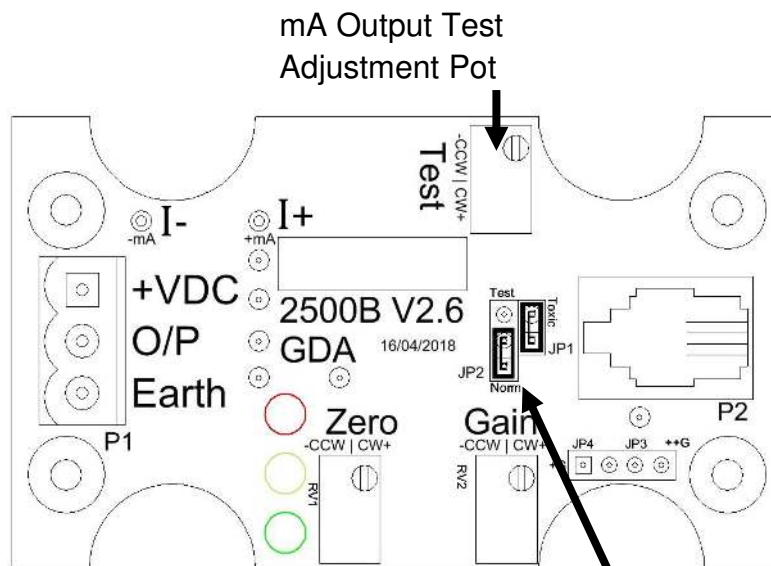

Figure 8: JP2 Jumper in Normal operation



6. Sensor Head Replacement (25xx-002):

When the sensor head is being replaced, the replacement sensor heads are supplied tested **but will require calibration when installed**, follow these instructions on how to remove used sensor and install new sensor without damaging the sensor. **Gloves are recommended when removing the brass sensor head to protect your hand from cuts.**

1. Remove the lid of the enclosure (4 screws).
2. Disconnect Incoming Cable Connector (green 3 pin) located on the left of the main board.
3. Disconnect the Sensor Assembly Connector (Figure 4).
4. Disconnect the sensor earth wire from the Incoming Cable Connector.
5. Gently pull the sensor cable towards the top of the case to clear any obstructions from the main board and the incoming power cable.
6. Rotate the sensor head anti-clockwise, while checking that the sensor cable in the enclosure is not catching on anything or that cable is not twisting, until sensor head is removed. **Caution:** the brass thread can be sharp, use caution when loosening the sensor.
7. When installing the new sensor head, guide the sensor cable into the enclosure through the sensor mounting hole.
8. Rotate the new sensor head clockwise, while checking that the sensor cable in the enclosure is not catching on anything or that cable is not twisting, until **hand tight**. **Caution:** the brass thread can be sharp, use caution when tightening the sensor.
9. Connect the sensor cable from the sensor head in to the Sensor Assembly Connector without putting stressful bends on the sensor cable.
10. Reconnect the replacement sensor Earth cable to the Incoming Cable Connector.
11. Reconnect the Incoming Cable Connector into the socket on main board.
12. Ensure the Gas selection jumper is in see Figure 5 on page 10.
13. Proceed to calibration of sensor.



Figure 9: Replacement Sensor



7. Revision History

Version	Contents	Date
1	Initial revision of the 2500 Manual HW: V2.6	20 Feb, 2019
1.1	Oxygen Sensor head requires Toxic jumper	13 Jan, 2020
2.0	Enclosure updated	20 Feb, 2020

This product and operating manual are subject to change without prior notice for the improvement of product performance and ease of use.



Gas Detection (Australia) Pty. Ltd.

Unit K1, USQ, Baker Street Toowoomba, QLD 4350

PO BOX 597, Darling Heights, QLD 4350

www.gasdetectionaustralia.com.au

+61 7 4613 5111

sales@gasdetect.com.au

